



Thank you for purchasing Pocahontas Aluminum Company's Concession Series. We feel you will be greatly satisfied with your purchase, and we would like to guide you with the installation.

In order to complete this installation with ease, please insure your rough opening is square and plum.

IMPORTANT: Don't not remove shipping clips, or open door/awning until door/awning is completely installed.

Step 1

Install concession door/awning from outside of your truck/trailer using the outside flange and fasteners that apply to your application.

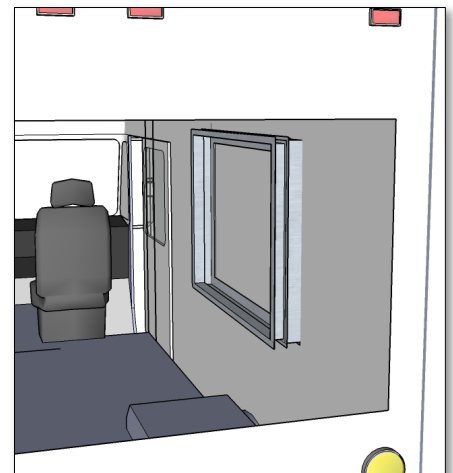
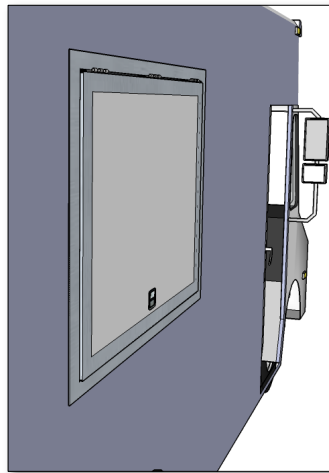
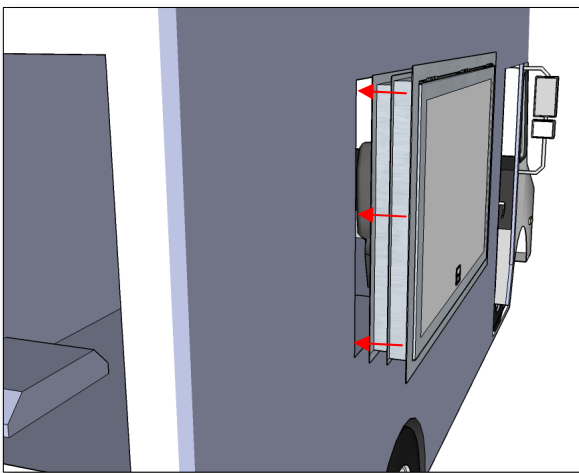

Step 2

Once your door/awning is firmly secure remove shipping clips and install gas prop brackets. First install one bracket on your door/awning's frame 18-1/4" down from inside of top of the frame. Ball stud should be facing outward.

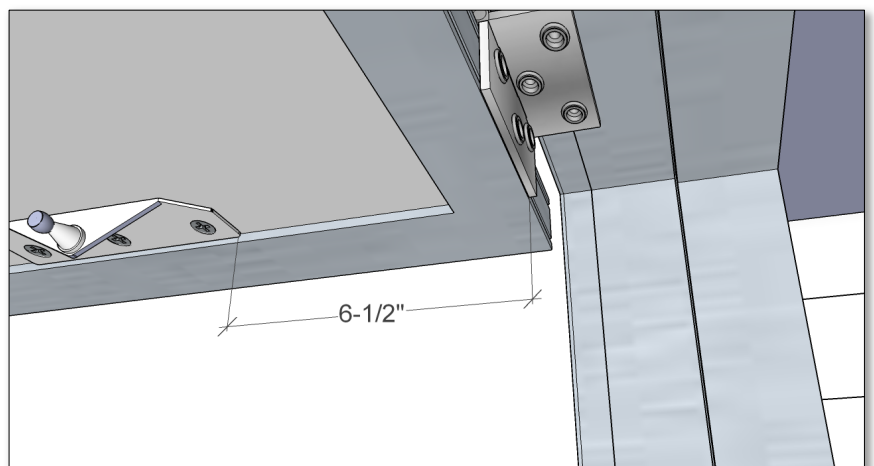
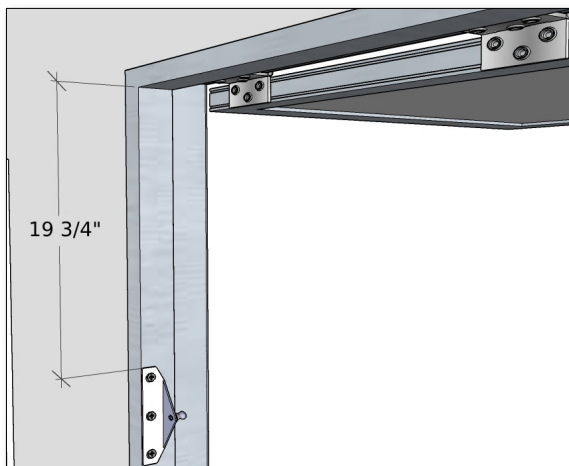

Install second gas prop bracket 6-1/2" from top of door frame with ball stud facing the center of the door/awning. Do not mount bracket on extrusion.



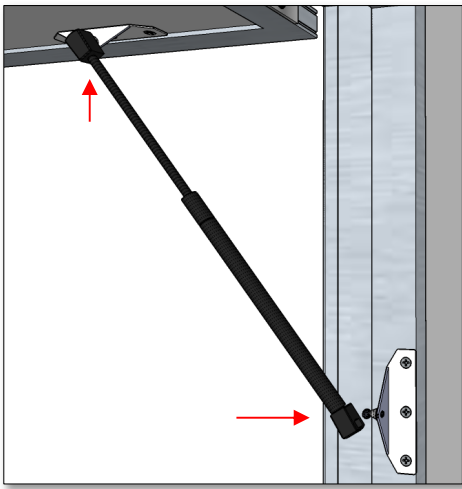

Snap extended gas shock onto ball studs of brackets.
Repeat all of step 2 on opposite side.

Step 3

Now that your door/awning and support system is installed, and if purchased, it is time to install your concession window. Install the outside window's flange to the inside flange of the door/awning. Attach window to door/awning's frame with fasteners that apply to your application.

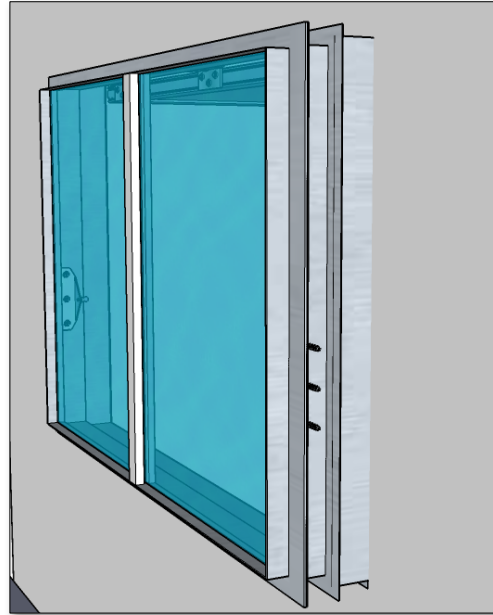
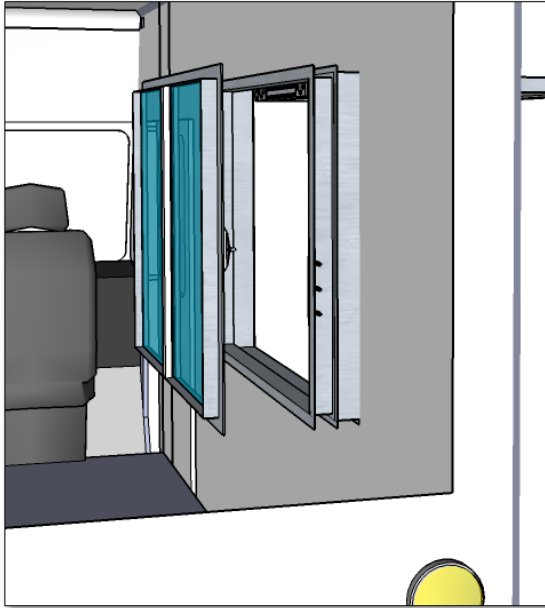

Window Only Option

Install concession window from outside of your truck/trailer using the outside flange and fasteners that apply to your application.

